

MAXIM

5-Tap Silicon Delay Line

MXD1000

General Description

The MXD1000 silicon delay line offers five equally spaced taps with delays ranging from 4ns to 500ns and a nominal accuracy of $\pm 2\text{ns}$ or $\pm 5\%$, whichever is greater. Relative to hybrid solutions, this device offers enhanced performance and higher reliability, and reduces overall cost. Each tap can drive up to ten 74LS loads.

The MXD1000 is available in multiple versions, each offering a different combination of delay times. It comes in the space-saving 8-pin μMAX package, as well as an 8-pin SO or DIP, allowing full compatibility with the DS1000 and other delay line products.

Features

- ◆ Improved Second Source to DS1000
- ◆ Available in Space-Saving 8-Pin μMAX Package
- ◆ 20mA Supply Current (vs. Dallas' 35mA)
- ◆ Low Cost
- ◆ Delay Tolerance of $\pm 2\text{ns}$ or $\pm 5\%$, whichever is Greater
- ◆ TTL/CMOS-Compatible Logic
- ◆ Leading- and Trailing-Edge Accuracy
- ◆ Custom Delays Available

Applications

- Clock Synchronization
- Digital Systems

Ordering Information

PART	TEMP. RANGE	PIN-PACKAGE
MXD1000C/D__	0°C to +70°C	Dice*
MXD1000PA__	-40°C to +85°C	8 Plastic DIP
MXD1000PD__	-40°C to +85°C	14 Plastic DIP
MXD1000SA__	-40°C to +85°C	8 SO
MXD1000SE__	-40°C to +85°C	16 Narrow SO
MXD1000UA__	-40°C to +85°C	8 μMAX

*Dice are tested at $T_A = +25^\circ\text{C}$.

Note: To complete the ordering information, fill in the blank with the part number extension from the Part Number and Delay Times table (located at the end of this data sheet) to indicate the desired delay per output.

Functional Diagram appears at end of data sheet.

Pin Configurations

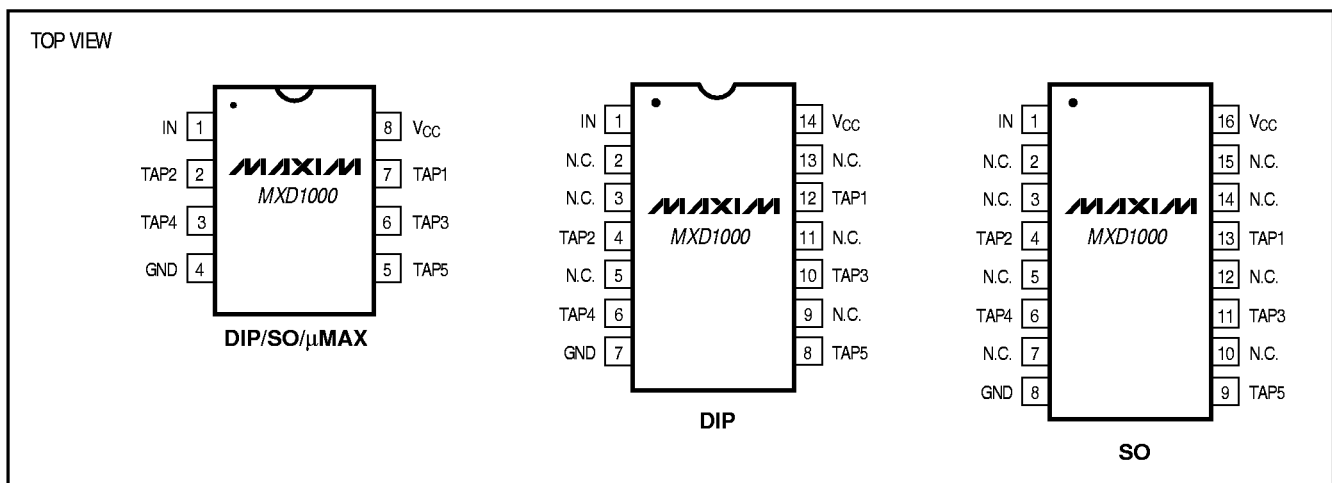

5-Tap Silicon Delay Line

ABSOLUTE MAXIMUM RATINGS

V _{CC} to GND	-0.5V to +6V	8-Pin SO (derate 5.9mW/°C above +70°C)	471mW
All Other Pins	-0.5V to (V _{CC} + 0.5V)	16-Pin Narrow SO (derate 8.7mW/°C above +70°C)	696mW
Short-Circuit Output Current (1sec)	50mA	8-Pin μMAX (derate 4.1mW/°C above +70°C)	330mW
Continuous Power Dissipation (T _A = +70°C)		Operating Temperature Range	-40°C to +85°C
8-Pin Plastic DIP (derate 9.1mW/°C above +70°C)	727mW	Storage Temperature Range	-65°C to +160°C
14-Pin Plastic DIP (derate 10.0mW/°C above +70°C)	800mW	Lead Temperature (soldering, 10sec)	+300°C

Stresses beyond those listed under "Absolute Maximum Ratings" may cause permanent damage to the device. These are stress ratings only, and functional operation of the device at these or any other conditions beyond those indicated in the operational sections of the specifications is not implied. Exposure to absolute maximum rating conditions for extended periods may affect device reliability.

ELECTRICAL CHARACTERISTICS

(V_{CC} = +5.0V ±5%, T_A = -40°C to +85°C, unless otherwise noted. Typical values are at T_A = +25°C.) (Note 2)

PARAMETER	SYMBOL	CONDITIONS	MIN	TYP	MAX	UNITS
Supply Voltage	V _{CC}	(Note 3)	4.75	5.00	5.25	V
Input Voltage High	V _{IH}	(Note 3)	2.2			V
Input Voltage Low	V _{IL}	(Note 3)			0.8	V
Input Leakage Current	I _L	0V ≤ V _{IN} ≤ V _{CC}	-1		1	μA
Active Current	I _{CC}	V _{CC} = 5.25V, period = minimum (Notes 4, 5)		20	75	mA
Output Current High	I _{OH}	V _{CC} = 4.75V, V _{OH} = 4.0V			-1	mA
Output Current Low	I _{OL}	V _{CC} = 4.75V, V _{OL} = 0.5V	12			mA
Input Capacitance	C _{IN}	T _A = +25°C (Note 6)		5	10	pF

TIMING CHARACTERISTICS

(V_{CC} = +5.0V ±5%, T_A = +25°C, unless otherwise noted.)

PARAMETER	SYMBOL	CONDITIONS	MIN	TYP	MAX	UNITS
Input Pulse Width	t _{WI}	(Note 7)	40% of TAP5			ns
Input-to-Tap Delay (leading edge)	t _{PLH}	(Notes 1, 8–12)		See Part Number and Delay Times table		ns
Input-to-Tap Delay (trailing edge)	t _{PHL}	(Notes 1, 8–12)		See Part Number and Delay Times table		ns
Power-Up Time	t _{PU}				100	ms
Period		(Note 7)	4(t _{WI})			ns

Note 1: Contact factory for ordering information.

Note 2: Specifications to -40°C are guaranteed by design, not production tested.

Note 3: All voltages referenced to GND.

Note 4: Measured with output open.

Note 5: I_{CC} is a function of frequency and TAP5 delay. Only an MXD1000__25 operating with a 40ns period and V_{CC} = +5.25V will have an I_{CC} = 75mA. For example, an MXD1000__100 will never exceed 30mA. See Supply Current vs. Input Frequency in *Typical Operating Characteristics*.

Note 6: Guaranteed by design.

Note 7: Pulse width and/or period specifications may be exceeded, but accuracy is application sensitive (i.e., layout, decoupling, etc.). The device will remain functional with pulse widths down to 20% of TAP5 delay, and input periods as short as 2(t_{WI}).

Note 8: Typical initial tolerances are ± with respect to the nominal value at +25°C and V_{CC} = 5V.

Note 9: Typical temperature tolerance is ± with respect to the initial delay value over a temperature range of -40°C to +85°C.

Note 10: The delay will also vary with supply voltage, typically by less than 4% over the supply range of V_{CC} = +4.75V to +5.25V.

Note 11: All tap delays tend to vary unidirectionally with temperature or voltage changes. For example, if TAP1 slows down, all other taps will also slow down; i.e., TAP3 can never be faster than TAP2.

5-Tap Silicon Delay Line

MXD1000

Typical Operating Characteristics

(VCC = +5V, TA = +25°C, unless otherwise noted.)

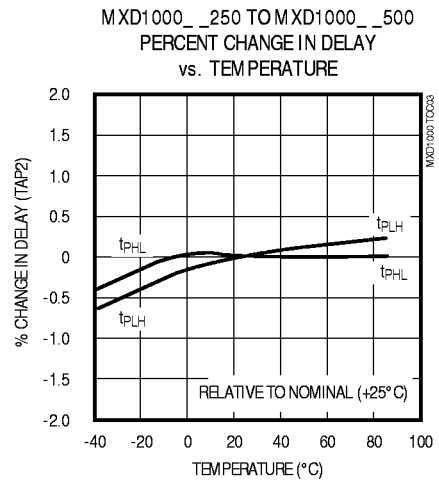
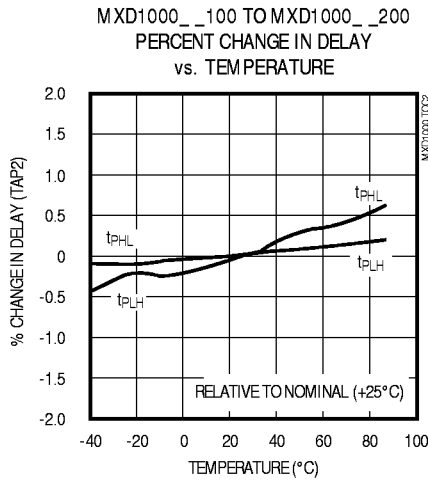
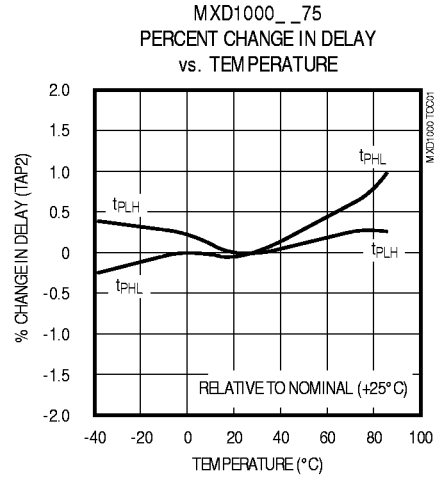
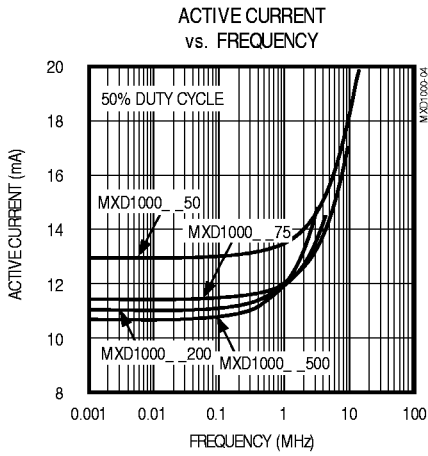

5-Tap Silicon Delay Line

Pin Description

PIN			NAME	FUNCTION
8-PIN DIP/SO/ μ MAX	14-PIN DIP	16-PIN SO		
1	1	1	IN	Signal Input
2	4	4	TAP2	40% of specified maximum delay
3	6	6	TAP4	80% of specified maximum delay
4	7	8	GND	Device Ground
5	8	9	TAP5	100% of maximum specified delay
6	10	11	TAP3	60% of specified maximum delay
7	12	13	TAP1	20% of specified maximum delay
8	14	16	VCC	Power-Supply Input
—	2, 3, 5, 9, 11, 13	2, 3, 5, 7, 10, 12, 14, 15	N.C.	No Connection. Not internally connected.

Note: Maximum delay is determined by the part number extension. See the Part Number and Delay Times table for more information.

Definitions of Terms

Period: The time elapsed between the first pulse's leading edge and the following pulse's leading edge.

Pulse Width (t_{w1}): The time elapsed on the pulse between the 1.5V level on the leading edge and the 1.5V level on the trailing edge, or vice-versa.

Input Rise Time (t_{RISE}): The time elapsed between the 20% and 80% points on the input pulse's leading edge.

Input Fall Time (t_{FALL}): The time elapsed between the 80% and 20% points on the input pulse's trailing edge.

Time Delay, Rising (t_{PLH}): The time elapsed between the 1.5V level on the input pulse's leading edge and the corresponding output pulse's leading edge.

Time Delay, Falling (t_{PHL}): The time elapsed between the 1.5V level on the input pulse's trailing edge and the corresponding output pulse's trailing edge.

Test Conditions

Ambient Temperature: +25°C \pm 3°C

Supply Voltage (V_{CC}): +5V \pm 0.1V

Input Pulse: High = 3.0V \pm 0.1V
Low = 0.0V \pm 0.1V

Source Impedance: 50 Ω max

Rise and Fall Times: 3.0ns max

Pulse Width: 500ns max (1ns for -500)

Period: 1 μ s (2ns for -500)

Each output is loaded with a 74F04 input gate. Delay is measured at the 1.5V level on the rising and falling edges. The time delay due to the 74F04 is subtracted from the measured delay.

5-Tap Silicon Delay Line

MXD1000

Part Number and Delay Times

Part Number Extension (MXD1000)	TAP1			TAP2			TAP3			TAP4			TAP5		
	Nom. Delay (ns)	Tolerance (ns)		Nom. Delay (ns)	Tolerance (ns)		Nom. Delay (ns)	Tolerance (ns)		Nom. Delay (ns)	Tolerance (ns)		Nom. Delay (ns)	Tolerance (ns)	
		Init.	Temp.		Init.	Temp.		Init.	Temp.		Init.	Temp.		Init.	Temp.
20 (Note 1)	4	2	1	8	2	1	12	2	1	16	2	1	20	2	1
25 (Note 1)	5	2	1	10	2	1	15	2	1	20	2	1	25	2	1
30 (Note 1)	6	2	1	12	2	1	18	2	1	24	2	1	30	2	1
35	7	2	1	14	2	1	21	2	1	28	2	1	35	2	1.1
40	8	2	1	16	2	1	24	2	1	32	2	1	40	2	1.2
45	9	2	1	18	2	1	27	2	1	36	2	1.1	45	2.3	1.4
50	10	2	1	20	2	1	30	2	1	40	2	1.2	50	2.5	1.5
60	12	2	1	24	2	1	36	2	1.1	48	2.4	1.5	60	3	1.8
75	15	2	1	30	2	1	45	2.3	1.4	60	3	1.8	75	3.8	2.3
100	20	2	1	40	2	1.2	60	3	1.8	80	4	2.4	100	5	3
125	25	2	1	50	2.5	1.5	75	3.8	2.3	100	5	3	125	6.3	3.8
150	30	2	1	60	3	1.8	90	4.5	2.7	120	6	3.6	150	7.5	4.5
175	35	2	1.1	70	3.5	2.1	105	5.3	3.2	140	7	4.2	175	8.8	5.3
200	40	2	1.2	80	4	2.4	120	6	3.6	160	8	4.8	200	10	6
250	50	2.5	1.5	100	5	3	150	7.5	4.5	200	10	6	250	12.5	7.5
500	100	5	3	200	10	6	300	15	9	400	20	12	500	25	15

Note 1: Contact factory for ordering information.

5-Tap Silicon Delay Line

Functional Diagram

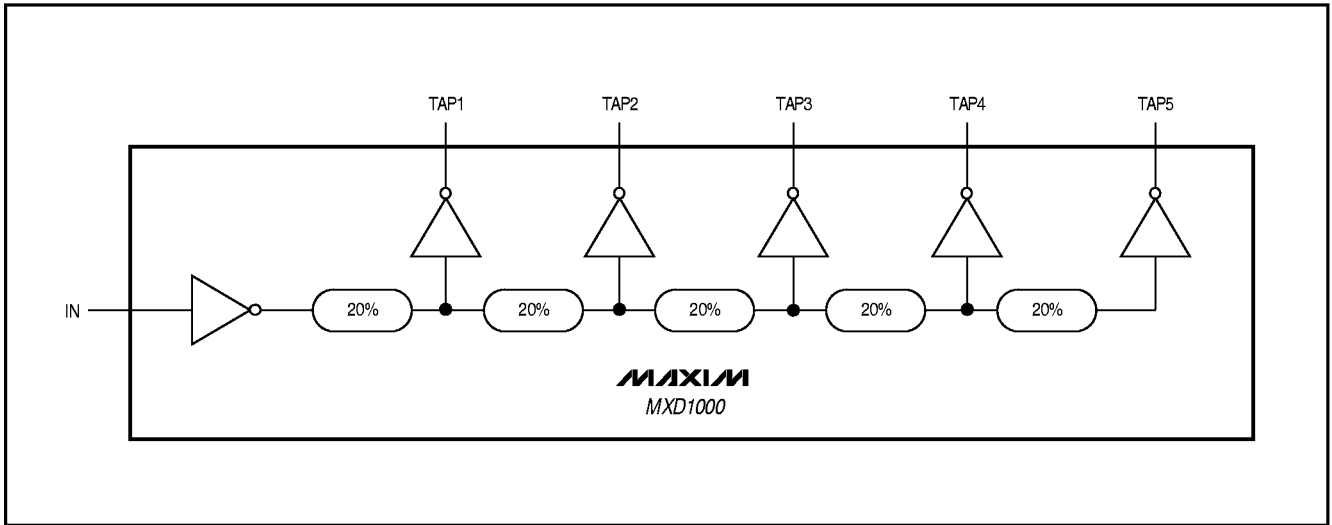

MXD1000

Chip Information

TRANSISTOR COUNT: 824

5-Tap Silicon Delay Line

MXD1000

Package Information

8LUMAXD.EPS

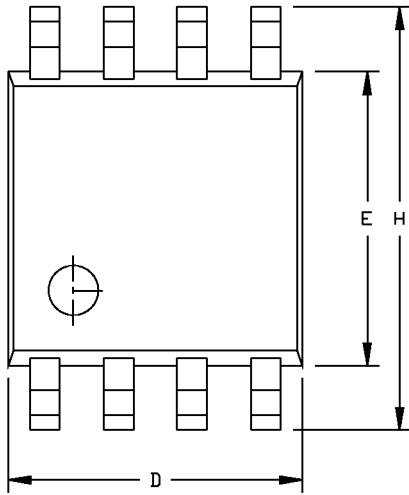

	INCHES		MILLIMETERS	
	MIN	MAX	MIN	MAX
A	0.036	0.044	0.91	1.11
A1	0.004	0.008	0.10	0.20
B	0.010	0.014	0.25	0.36
C	0.005	0.007	0.13	0.18
D	0.116	0.120	2.95	3.05
e	0.0256		0.65	
E	0.116	0.120	2.95	3.05
H	0.188	0.198	4.78	5.03
L	0.016	0.026	0.41	0.66
α	0°	6°	0°	6°

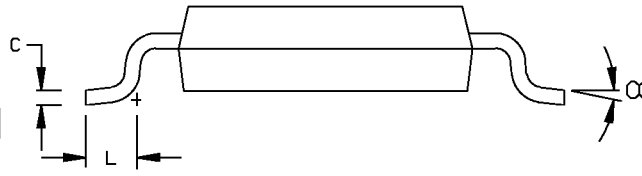
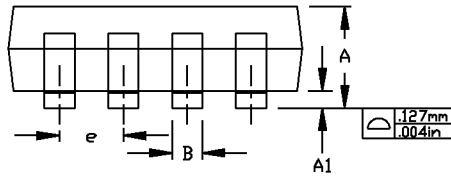

- NOTES:
1. D&E DO NOT INCLUDE MOLD FLASH.
 2. MOLD FLASH OR PROTRUSIONS NOT TO EXCEED .15mm(.006").
 3. CONTROLLING DIMENSION: INCHES

MAXIM
 PROPRIETARY INFORMATION
 TITLE:
 8LD uMAX PACKAGE OUTLINE DWG.
 APPROVAL: _____ DOCUMENT CONTROL NO: 21-0036 REV: D 1/1

Maxim cannot assume responsibility for use of any circuitry other than circuitry entirely embodied in a Maxim product. No circuit patent licenses are implied. Maxim reserves the right to change the circuitry and specifications without notice at any time.

8 _____ Maxim Integrated Products, 120 San Gabriel Drive, Sunnyvale, CA 94086 408-737-7600

Package Information

This section contains physical dimensions for all packages currently supplied by Maxim.

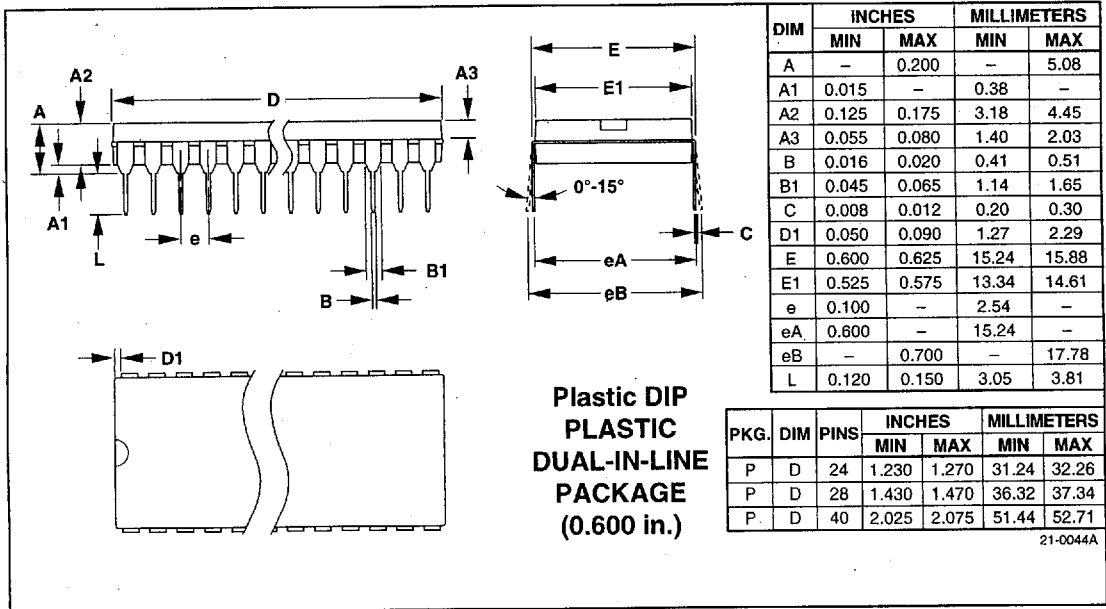
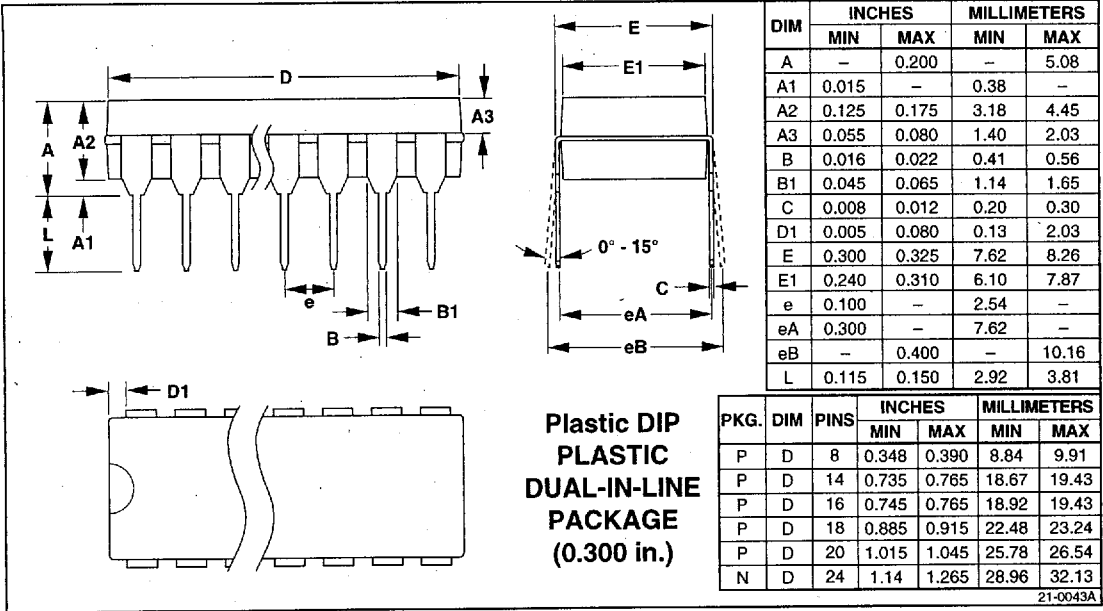

Package Information

